

EndoPilot Contra-Angle
User manual
Processing instruction

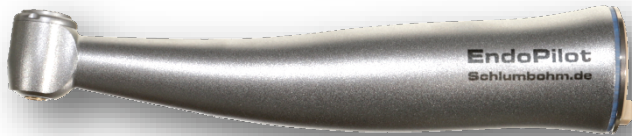

609.2210 v04 12.05.2020

Schlumbohm

Manufacturer information:

Schlumbohm GmbH & Co. KG
Klein Floyen 8-10
D-24616 Brokstedt
Germany

Phone: +49 (0) 4324 - 8929 - 0
Telefax: +49 (0) 4324 - 8929 - 29
post@schlumbohm.de
www.schlumbohm.de

WEEE reg. no.: DE 88116129



The manufacturer reserves the right to change the information and data contained in this user manual without prior notice. On request, the user manual can be provided in different languages.

This user manual has been prepared with the greatest possible care. However, as errors can never be fully excluded, we would appreciate any information at any time so we can improve the documentation for you. Please contact us directly in such an event. Also, should you have any further questions, please do not hesitate to contact us.

(The data contained in this manual are referred to in the document: 50669 -AEN Rev.004/24.10.2018)

Table of contents Page

1.	Introduction	3
2.	Symbols used.....	4
3.	First usage – Safety notes.....	5
4.	Product description.....	6
5.	Operation	6
5.1.	Assembly and removal.....	6
5.2.	Changing of the root canal instruments.....	7
5.3.	Test run	7
6.	Hygiene and maintenance	8
6.1.	Cleaning agents and disinfectants	8
6.2.	Limitations on processing.....	8
6.3.	Initial treatment at the point of use	9
6.4.	Manual cleaning	10
6.5.	Manual disinfection	10
6.6.	Automated cleaning and disinfection	11
6.7.	Drying	11
6.8.	Inspection, Maintenance and Testing	11
6.9.	Lubrication.....	12
6.10.	Testing after Lubrication	12
6.11.	Packaging.....	13
6.12.	Sterilization.....	13
6.13.	Storage.....	14
7.	Accessories.....	14
8.	Technical data	14
8.1.	Temperature information	15
8.2.	Ambient conditions	15
9.	Disposal	15
9.1.	Disposal of the contra-angle	15
9.2.	Disposal of the packaging material	15
10.	Liability	16
11.	Service	16

1. Introduction

Customer satisfaction is our top priority. The present device was developed, manufactured and tested in line with all applicable legal and normative provisions.

For your safety and for the safety of your patients

Prior to first use, please read through the present instructions. The user manual is intended to give you information and explanations on the use of the device to ensure undisturbed, economic and safe treatments.

It explains how to use your medical device and guarantee a smooth and efficient operation.



Observe the safety notes.

Intended use

Dental contra-angle for the mechanical preparation of root canals on the patient using root canal instruments or root canal instruments with alternating movement.

Improper use may lead to damage of the contra-angle, resulting in and increased risk and hazard to the patient and third persons.

Qualification of the user

We have based our development and design of the medical device on the dentists target group.

The medical device must be used in accordance with these Instructions for use.







The medical device has no components that can be repaired by the user.







Skilled application

This medical device is intended solely for use by professionals in dental medicine, in compliance with the applicable occupational health and safety regulations, safety precautions, and the present instructions for use. It may only be reprocessed and maintained by persons having undergone training on the prevention of infections, self-protection and protection of patients. Improper use, e.g. inadequate hygiene and improper maintenance, non-observance of the present instructions for use, or the use of non-authorised accessories and spare parts, shall exempt us from any warranty or other claims.

2. Symbols used

Description of the symbols used.

Symbol	Description
 0482	The product complies with the requirements of EU Regulations / No. of notified body
	Caution Indicates the need for the user to consult the instructions for use for important cautionary information such as warnings and precautions that cannot, for a variety of reasons, be presented on the medical device itself. ISO 15223-1:2016 / Ref. 5.5.4 For example: Warning, risk of injuri
	Attention! (to prevent damages occurring)
	Thermo washer, disinfectable
	Steam sterilization up to he stated temperature
	General explanations

	<p>Catalogue Number Indicates catalogue number, part number of device ISO 15223-1:2016 / Ref. 5.1.6</p>
	<p>Serial Number Serial number so the device can be identified ISO 15223-1:2016 / Ref. 5.1.7</p>
	<p>Waste Collection Separate collection for waste of electrical and electronic equipment. EN 50419 - Marking of electrical and electronic equipment in accordance with article 11(2) of Directive 2002/96/EC Do not dispose of with domestic waste</p>
	<p>Data Matrix Code for product information including UDI (Unique Device Identification)</p>
	<p>Date of Manufacture Indicates the medical device manufacturer / Indicates Date of Manufacturer ISO 15223-1:2016 / Ref. 5.5.1 /5.1.3</p>
	<p>Medical Device This item is a medical-device ISO 15223-1 draft</p>
	<p>Caution! According to Federal law, this medical device may only be sold by or on the order of a dentist, physician or any other medical practitioner licensed by the law of the State in which he or she practices and who intends to use or order the use of this medical device.</p>

3. First usage – Safety notes

- Before using the medical device for the first time, store it at room temperature for 24 hours.
- The operation of the medical device is permitted only on supply units which correspond to the standards IEC 60601-1 (EN 60601-1) and IEC 60601-1-2 (EN 60601-1-2).
- Always ensure the correct operating conditions.
- Check the medical device for damage and loose parts each time before using (e.g. push-button).
- Do not operate the medical device if it is damaged.
- Only attach the medical device onto the motor when the motor is at a complete standstill.
- Do not activate the push-button of the medical device during operation. This leads to detachment of the root canal instrument and/or makes the medical device hot.
- Perform a test run each time before using.
- Do not touch the soft tissue with the contra-angle head (risk of burning due to the push-button heating up)!

Hygiene and maintenance prior to initial use



The medical device is sealed in PE film and not sterilized when delivered.
The PE film and the packaging are non-sterilizable.

Prior to first use, the contra-angle has to be cleaned, disinfected, lubricate and sterilized.
See chapter 6. "Hygiene and maintenance"

4. Product description

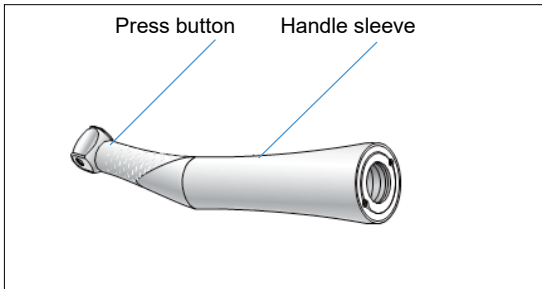

5. Operation

5.1. Assembly and removal



Do not insert assemble or remove the contra-angle while in operation!

1. Connect the contra-angle to the motor until it snaps into place
2. Check if the contra-angle is tightly fastened to the motor
3. Remove the contra-angle by pulling it in axial direction

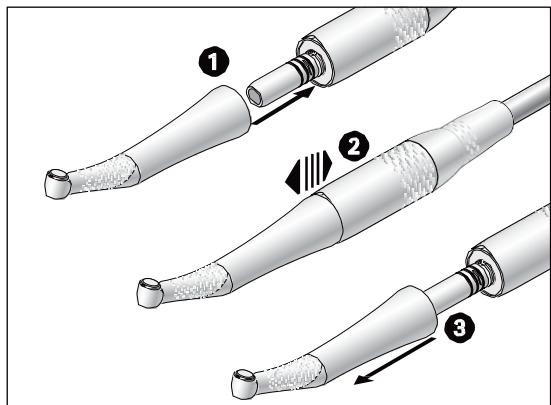

5.2. Changing of the root canal instruments



Root canal instruments

- Please make sure to solely use root canal instruments in perfect technical condition.
- Please observe the manufacturer's instructions.
- Please insert the root canal instrument only when the contra-angle is at still stand.
- Don't ever touch the root canal instrument when it is still rotating or running out.
- Don't ever press the press button on the contra-angle while the contra-angle is still rotating or running out. This may result in the root canal instrument loosening, or the press button getting hot.
- We recommend to use always a rubber dam.

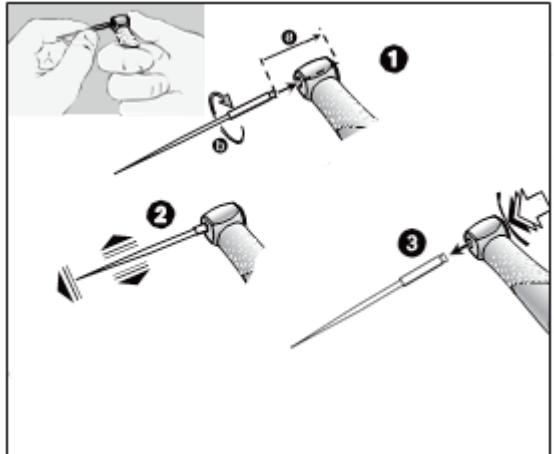

1. Insert the instrument until the stop position is reached (a) and turn it until it locks in place b).
2. Check if the instrument is safely locked in place by pulling it in axial direction (b).
3. To remove the instrument, press the press button.



Verify full engagement.

5.3. Test run



Do not hold the medical device at eye level

1. Insert the root canal instrument.
2. Start the contra-angle on the motor.
3. In case of operating malfunctions (for example vibrations, unusual noise, overheating), please make sure to put the contra-angle out of operation immediately and contact the Schlumbohm® customer service (see chapter 11).

6. Hygiene and maintenance



General notes

- Observe the specific guidelines, standards, directives and laws regarding cleaning, disinfection and sterilization in your country.
- The contra-angle may be reprocessed either manually or mechanically.
- Wear protective clothing, safety glasses, face mask and gloves.
- Remove the root canal instrument from the contra-angle.
- Disconnect the contra-angle from the motor.
- Please make sure to disinfect the contra-angle immediately after every treatment to flush out any liquids that might have penetrated the contra-angle (for example blood, saliva, etc.), and to prevent clogging of the internal parts.
- After manual or mechanical cleaning and disinfection and maintenance with oil, the contra-angle needs to be sterilized.
- Use only oil-free, filtered compressed air with a maximum operating pressure of 3 bar for manual drying.



6.1. **Cleaning agents and disinfectants**



- Read the notes, follow the instructions and heed the warnings provided by the manufacturers of cleaning
- Agents and/or disinfectants.
- Use only detergents which are intended for cleaning and/or disinfecting medical devices made of metal
- And plastic.
- It is imperative to comply with the concentrations and exposure times specified by the manufacturer of the disinfectant.
- Use disinfectants which have been tested and found effective by the Verbund für Angewandte Hygiene e.V (VAH = Association for Applied Hygiene), the Österreichischen Gesellschaft für Hygiene, Mikrobiologie und Präventivmedizin (ÖGHMP = Austrian Society for Hygiene, Microbiology and Preventive Medicine), the Food and Drug Administration (FDA) and the U.S. Environmental Protection Agency (EPA).



The user is responsible for validating its process if the specified cleaning agents and disinfectants are not available.

6.2. **Limitations on processing**



The product lifetime and the medical device's ability to operate correctly are mainly determined by mechanical stress during use and chemical influences due to processing.

Send worn or damaged contra-angles or contra-angles with material changes to the Schlumbohm® customer service.

Processing cycles:



We recommend a regular service for the contra-angle after 1000 processing cycles or one year.

6.3. Initial treatment at the point of use



- Clean the medical device immediately after every treatment, to flush out any liquid (e.g., blood, saliva etc.) and to prevent settling on the internal parts.
- Operate the medical device for at least 10 seconds at idle speed
- Ensure that all outlets are rinsed out



- Wipe the entire surface of the instrument with disinfectant.
- Remove the root canal instrument.
- Remove the contra-angle from the motor



Note that the disinfectant used during pre-treatment is only for personal protection and cannot replace the disinfectant step after cleaning.

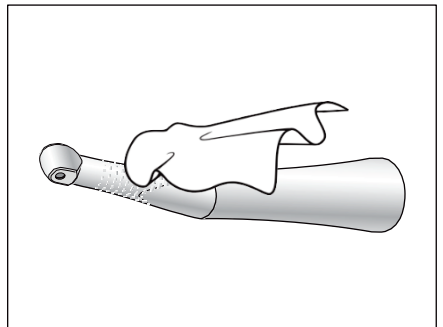

6.4. Manual cleaning



Do not place the contra-angle in liquid disinfectant or in an ultrasonic bath

1. Rinse contra-angle under running tap water. (<35°C / 95°F). Rinse and brush off all internal and external surfaces. Move moving parts back and forth several times.
2. Remove any liquid residues using oil-free, filtered compressed air.

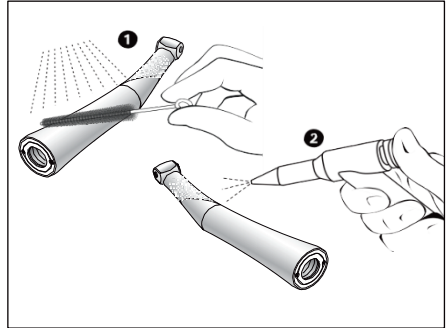

6.5. Manual disinfection



We recommend wiping down the contra-angle with disinfectant

Evidence of the medical device's basic suitability for effective manual disinfection was provided by an independent test laboratory using the »mikrozid® AF wipes« disinfectant (Schülke & Mayr GmbH, Norderstedt, Germany).

If this product is not available, »CaviWipes®« disinfectant (Metrex LLC, Orange, CA 92867 USA) is an alternative.

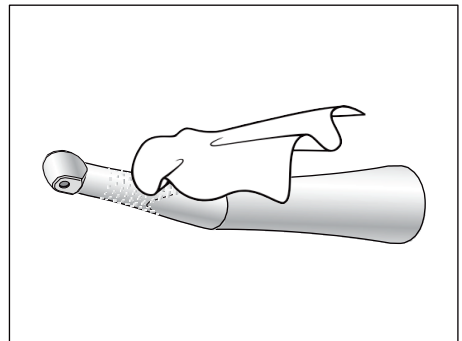

6.6. Automated cleaning and disinfection



We recommend automated cleaning and disinfection using a washer-disinfector (WD).

Read the notes, follow the instructions and heed the warnings provided by the manufacturers of washer-disinfectors, cleaning agents and/or disinfectants.

Evidence of the medical device's basic suitability for effective automated disinfection was provided by an independent test laboratory using the »Miele PG 8582 CD« washer-disinfector (Miele & Cie. KG, Gütersloh) and the »Dr. Weigert neodisher® MediClean forte« cleaning agent (Dr. Weigert GmbH & Co. KG, Hamburg).



Cleaning at 55 °C (131 °F) – 5 minutes

Disinfection at 93 °C (200 °F) – 5 minutes

6.7. Drying



Ensure that the medical device is completely dry internally and externally after cleaning and disinfection.

Remove any liquid residues using oil-free, filtered compressed air.

6.8. Inspection, Maintenance and Testing



- Check the contra-angle after cleaning and disinfection for damage, visible residual soiling and surface changes.
- Reprocess the contra-angle if it is still soiled.
- Sterilize the contra-angle after cleaning, disinfection and lubrication.

6.9. Lubrication



Lubricate the dry medical device immediately after cleaning and/or disinfection.

Recommended lubrication cycles:

- Essential after every internal cleaning
- Before each sterilization or
- After 30 minutes of use or at least once daily
- Chucking system once a week

1.

Lubricate the contra-angle with oil, for example with W&H Service Oil F1, MD-400. Please follow the instructions of use printed on **the** aerosol can and on the packaging.

Or

2.

Lubricate the contra-angle in an automatic instrument maintenance device, for example in the W&H Assistina 301plus (see instructions for use coming with the device).

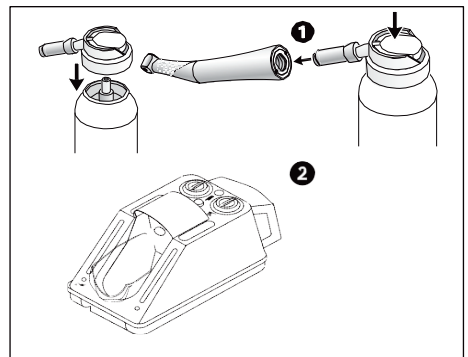

After maintenance, please place the contra-angle in an upright position on a clean disposable cloth. This way, excessive oil may drip off so that it cannot get into the motor.

6.10. Testing after Lubrication



1. Hold the contra-angle with the head pointing downwards.
2. Let the contra-angle run briefly so that excess oil can escape. To do so, please start the calibration function of the EndoPilot. In case of dirt leaking from the contra-angle, the entire hygiene and maintenance procedure must be repeated.
3. Wipe the contra-angle with disinfectant wipes.

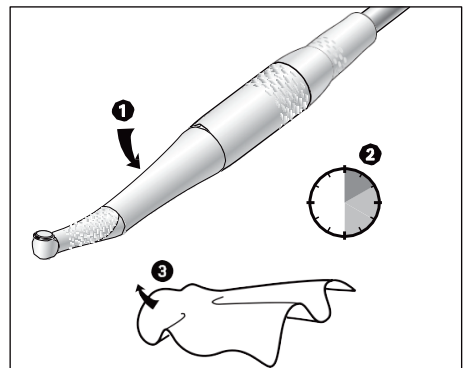

6.11. Packaging



Pack the contra-angle in sterilization packages that meet the following requirements:

- The sterilization package must meet the applicable standards in respect of quality and use and must be suitable for the sterilization method.
(For the US: The package must follow the FDA requirements)
- The sterilization package must be large enough for the sterilization goods.
- The filled sterilization package must not be under tension.

6.12. Sterilization



We recommend sterilization according to EN 13060, EN 285 or ANSI/AAMI ST79.



Read the notes, follow the instructions and heed the warnings provided by the manufacturers of steam sterilizers.

The program selected must be suitable for the medical device.

Recommended sterilization procedure:

- Fractionated pre-vacuum process (type B)
- Gravity displacement process (type N)
- Sterilization time at least 30 minutes at 121°C (250°F) or at least 3 minutes at 134°C (273°F)
- Maximum sterilization temperature 135°C (275°F)



Evidence of the medical device's basic suitability for effective sterilization was provided by an independent test laboratory using the LISA 517 B17L steam sterilizer (Firma W&H Sterilization S.r.l., Brusaporto (BG)) and the CertoClav MultiControl MC2-S09S273 gravitation sterilizer (CertoClav GmbH, Traun).

- Fractionated pre-vacuum process (type B):
temperature 134°C (273°F) – 3 minutes*
- Gravity displacement process (type N):
temperature 121°C (250°F) – 30 minutes**

* According to EN 13060:2014 A1:2018, EN 285:2015, ISO 17665:2017

** according to ANSI/AAMI ST55:2016, ANSI/AAMI ST79:2017

6.13. Storage



Store sterile goods dust-free and dry

The shelf life of the sterile goods depends on the storage conditions and type of packaging

7. Accessories



The equipment used must be suitable for dental instruments and contra-angles.

For example:

REF 00030140 W&H Assistina 301plus

REF 10940021 W&H Service Oil F1, MD-400 (6 pcs)

REF 02038200 W&H Spray adaptor

8. Technical data

Gear ratio	1:1
Motor coupling in compliance with standard	ISO 3964: 2016 + Amm.2018
Recommended root canal instruments* Shank diameter of the instruments (Type 1) acc. to ISO14457:2017	NiTi files for the mechanical preparation of root canals Ø 2,35* mm
Minimum insertion depth	until the instrument is firmly locked in place
A maximum motor rotational speed for NiTi files of 2000 rpm: equals a rotational speed of operation of 2000 rpm	2000 rpm

* By choosing the right conditions of operation, the user has to make sure to exclude any hazard to the user, patient or third persons. Please observe the instructions of the root canal instrument manufacturer (in terms of speed, torque and type of movement))

8.1. Temperature information

Temperature of the medical device on the operator side:
maximum 55°C (131°F)

Temperature of the medical device on the patient side:
maximum 50°C (122°F)

Temperature of the working part (rotary instrument): maximum
41°C (105,8 °F)

8.2. Ambient conditions

Temperature during storage and transport: -40°C to +70°C (-40°F to 158°F)

Humidity during storage and transport: 8% to 80% (relative), non-condensing

Temperature during operation: +10°C to +35°C (+50°F to +95°F)

Humidity during operation: 5% to 80% (relative), non-condensing

9. Disposal



Ensure that the parts are not contaminated on disposal.

9.1. Disposal of the contra-angle



Follow your local and national laws, directives, standards and guidelines for disposal.

9.2. Disposal of the packaging material

The packaging materials were duly selected to allow an environmentally friendly disposal, therefore, all components can be recycled. Please dispose of all no longer required packaging materials in the collection and recycling system. In so doing, you can contribute to recycle raw materials and to reduce waste.

10. Liability

Schlumbohm® warrants this product against defects in materials and workmanship for the period of one year from the date of the original invoice. The product warrant provided by Schlumbohm® includes the repair or the replacement of the entire device or individual parts. The decision whether to replace or repair is entirely up to the manufacturer.

In the event of an alleged defect during warranty, the customer has to inform the customer service immediately. The customer service will give further instructions. Normally you will be asked to return the contra-angle. The costs of returning the product are at the sender's expense.

Application errors exclude a warranty. Schlumbohm® does not warrant for wear and contamination of the handpieces and contra-angles.

Schlumbohm® declines all responsibility for any damage caused as a result of the clinical application of its products. Irrespective of whether or not such use is associated with other medical devices (e.g. pacemakers).

11. Service

In case of operating malfunctions, you are requested to immediately contact your dealer or the Schlumbohm® customer service. Repair and maintenance may only be carried out by the Schlumbohm® customer service



Ensure that the medical device has been completely processed before returning it.

Manufacturer:

Schlumbohm GmbH & Co. KG
Klein Floyen 8-10
D-24616 Brokstedt
Germany

Phone: +49-(0)4324 - 8929 - 0
Fax: +49-(0)4324 - 8929 - 29
post@schlumbohm.de
www.schlumbohm.com